



Embracing Finest Moments

Built-in Hobs | Cooker Hoods | Built-in Ovens | Free Standing Cookers

KITCHEN CATALOGUE



EMBRACING FINEST MOMENTS

Our Story

The essence of EF extends beyond a shared passion for cooking. We recognise that behind the comfort of every family is a well-designed home.

Our concept first sparked when we came across the fine European designs for household appliances. We wondered how the sleek aesthetics and new functions could be ported over to a Singaporean household.

Hence, we established EF to marry these Eastern and Western ideals into homes. It has since been our charge over the last few decades to serve the needs of ever-evolving local homeowners.

A mighty stove with powerful flames to cater to local cooking styles? A sturdy home gadget that can handle the demands of a growing family? We build our reliable appliances with these considerations in mind.

As part of the Casa Holdings Ltd family and a pivotal player in the household appliance industry, we continually strive to fuse progressive, contemporary European aesthetics with functional designs based on detailed research, so as to deliver the best solution for each unique customer.

We are dedicated to achieving our core values of Care, Accountability, Support and Ambition in every personal interactions with you so that you can live your most comfortable life. At the same time, we want to bring to you the convenience and versatility of a modernized store.

To us, there is no better motivator and reward for our pursuits than the pure satisfaction of our customers at ease with their new appliances.





TABLE OF CONTENTS

01	ELECTRIC HOBS	41	TELESCOPIC HOODS
03	INDUCTION HOBS	43	BUILT IN OVENS
07	CERAMIC HOBS	45	Combi Ovens
09	GAS HOBS	49	Multifunctional and Conventional Ovens
17	Dual Flame Control Hobs	51	MICROWAVE OVENS
19	Flush Design Hobs	52	Microwave Ovens Features
21	COOKER HOODS	55	FREE STANDING COOKER
22	Choosing the Right Hood	57	EF RECIPE - LAKSA BAKED PASTA
23	Cooker Hoods Features	58	BUILT IN DIMENSIONS
25	ISLAND HOODS	58	Built In Hobs Dimensions
27	CHIMNEY HOODS	59	Built In Hoods Dimensions
31	SLIM HOODS	60	Built In Oven Dimensions
33	SEMI INTEGRATED HOODS		
35	Oil Tray Hoods		
37	High Suction Power Hoods		
39	Power Slim Hoods		

ELECTRIC HOBS

Electric Hobs are sleek and classy fit for any modern kitchen. Featuring GERMAN Schott Ceran glass and designed with unique beveled edge, the smooth and flat surface makes cleaning a breeze in a wipe.



INDUCTION HOB

Heat is created by powerful, high frequency electromagnets which generate magnetic currents that directly heat up the cookware. The glass surface of the hob is not heated.



RADIANT CERAMIC HOB

Coiled heating elements under the tempered ceramic glass are electronically heated. Heat transfers from beneath the hob, through the glass surface, then to the cookware.

VS

ENERGY EFFICIENCY

Cookware heats up directly, without heating up the glass surface or environment. High energy efficiency.



The cooking zone on the glass surface heats up over a prolonged period to conduct heat transfer.

HEATING

Cookware heats up almost instantly. 2 litres of water boils two times faster than on ceramic hob, thanks to consistent magnetic heating.



Cookware heats up slower via heat transfer through the glass surface. Heating element cycles intermittently to maintain temperature.

SAFETY

Glass surface remains cool to touch with minimal residual heat from cookware.



Glass surface will be burning hot after cooking. Cooking zone takes a longer time to cool down.

COOKWARE

Only cookware with magnetic bottom will work with induction hob. Check for  or "IH" symbol, or test it with a magnet sticking firmly to the base.



All types of cookware with flat and even bottom may be used, including claypot, glass and ceramic pots.

CONTROL

Cookware reacts almost instantly to any change in heating level, with less chances of burning your food.



Cooking zone on glass surface takes time to react by heating up or cooling down to the heating level.

EASY TO CLEAN

Glass surface of induction hob does not heat up, thus any spillage is unlikely to burn into the surface, making cleaning effortless.



Glass surface heats up to high temperatures, thus any spillage is likely to burn into the surface. Remove spills safely while it is warm.

PRICE

Induction hobs may cost more to buy, but it is quicker and cheaper to operate.



Ceramic hobs may be less energy efficient to operate, but it costs less to buy.



ELECTRIC HOBS



INDUCTION HOBS

All EF Induction Hobs are equipped with intuitive and ergonomic features:

SCHOTT
CERAN®



SENSOR SLIDING TOUCH CONTROL

Control the cooking levels and timer by just sliding left and right instead of having to press +/- button several times



PAN RECOGNITION SENSOR

The cooking zone will automatically detect suitable cookware. A visible symbol blinks to indicate no cookware or incorrect cookware used.



99 MINS TIME CONTROL

The timer can be used as a minute minder for cooking alerts, or an automatic switch off timer. Both can be set from 1 to 99 minutes



9 COOKING LEVELS

It ranges from level 1 at the lowest heating to level 9 at the highest heating power.



BOOST FUNCTION

The function allows the cooking zone to operate at the maximum power for a maximum of 5 minutes. Enables faster heating up.



OVERFLOW SAFETY DEVICE

Safety feature switches off hob if liquid boils over and flows to the control panel.



RESIDUAL HEAT INDICATOR

Visible "H" sign on the display to warn of hot surface.



CHILD LOCK

The function locks the touch-control keys to prevent unwanted activation.



AUTOMATICALLY SAFETY SWITCH OFF

The cooking zone will switch off automatically after a maximum preset time if the zone is switched on and no further operation is performed.

POWER MANAGEMENT

Preset for 13amp power, with flexibility to adapt to 16/25/32amp

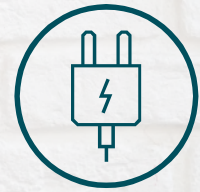

4 INDUCTION ZONES

Featuring two Flexi Induction Cooking Zones which constitutes of four smaller cooking zones. you may individually select each zone to cook.



2 FLEXI ZONES

Combine two of the cooking zones to form a larger cooking area to fit larger cookware. Suitable for teppanyaki plate and long tray.



GERMAN SCHOTT CERAN®
GLASS SURFACE PRINTED WITH
FINE PRINT FINISHING

Stylish matte black and scratch-resistant surface; exuding elegance while adding a modern touch to your kitchen.

60CM

FLEXI ZONE INDUCTION HOB

INDUCTION HOB





HB BI 584 FA
60CM INDUCTION HOB WITH FLEXI ZONE

4 Induction Zones with 2 Flexi Zones

- Flexi Zone, Left and Right: 3.0kW (Booster 3.6kW)
- Front - Left and Right: 1.8kW (Booster 2.4kW)
- Rear - Left and Right: 1.8kW (Booster 2.4kW)

Power Management (Adaptable to 2.8kW, 3.5kW, 6.0kW)

Max. Power: 7.2kW / Default Power: 2.8kW

32Amp / 220~240V/50Hz

Product Size: W590 x D520 x H58mm

Cut-out Size: W560 x D490mm

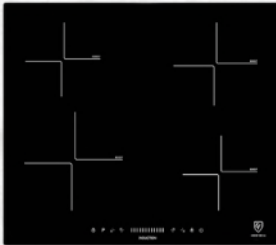

HB BI 583 A
60CM INDUCTION HOB

4 Induction Zones

- Front Left and Rear Right: 1.8kW (Booster 2.1kW)
- Front Right and Rear Left: 1.2kW (Booster 1.5kW)

Power Management (Adaptable to 2.8kW, 3.5kW, 6.0kW)

Max. Power: 7.2kW

32Amp / 220~240V/50Hz

Product Size: W590 x D520 x H58mm

Cut-out Size: W560 x D490mm

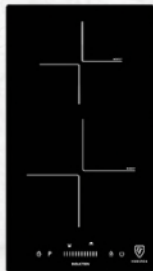

HB BI 292 A
30CM INDUCTION DOMINO HOB

2 Induction Zones

- Front: 1.8kW (Booster 2.1kW)
- Rear: 1.2kW (Booster 1.5kW)

Max. Power: 3.4kW

15 Amp/ 220~240V/50Hz

Product Size: W290 x D520 x H58mm

Cut-Out Size: W270 x D490mm

COOKING WITH PRECISION

Common Features:

SCHOTT
CERAN®



SENSOR SLIDING
TOUCH CONTROL



PAN RECOGNITION
SENSOR



99 MINS TIME
CONTROL

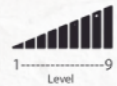

9 COOKING LEVELS



BOOSTER FUNCTION



OVERFLOW
SAFETY DEVICE



RESIDUAL HEAT
INDICATOR



CHILD LOCK



AUTOMATIC SAFETY
SWITCH OFF

INDUCTION HOBS



HB BI 2721 A 70CM INDUCTION HOB

2 Induction Zones

- Left and Right - 1.8kW (Booster 2.1kW)

Max. Power: 2.9kW

13 Amp/ 220~240V/50Hz

Product Size:

W730 x D420 x H58mm

Cut-Out Size:

W680 x D380mm



HB BI 2730 A 70CM INDUCTION HOB

2 Induction Zones

- Left and Right - 1.8kW (Booster 2.1kW)

Max. Power: 3.4kW

15 Amp / 220~40V/50Hz

Product Size:

W730 x D420 x H58mm

Cut-out Size:

W680 x D380mm

HB IV 2734 A 70CM INDUCTION RADIANT COMBI HOB

2 Combi Zones

- Left Radiant: 1.1kW to 2.2kW
- Right Induction: 1.8kW (Booster 2.1kW)

Power Management (Max. 3.4kW)

15 Amp/ 220~240V/50Hz

Product Size:

W730 x D420 x H58mm

Cut-Out Size:

W680 x D380mm



CERAMIC HOBS

EF Ceramic Hobs provide classic cooking with supreme convenience. The glass surface not only looks sleek and classy, they are easy-to-clean.

Thanks to an integrated Sensor Touch Control, you always maintain perfect control for maximum safety. Other intuitive and ergonomic features:



SENSOR TOUCH CONTROL

The touch controls respond to the ball of your finger, it is easy to operate.



99 MINS TIME CONTROL

The timer can be used as a minute minder or an automatic switch off timer. Both can be set from 1 to 99 minutes



9 COOKING LEVELS

It ranges from level 1 at the lowest heating to level 9 with the highest heating power.



OVERFLOW SAFETY DEVICE

Safety feature switches off hob if liquid boils over and flows to the control panel.



RESIDUAL HEAT INDICATOR

Visible "H" sign on the display to warn of hot surface.



CHILD LOCK

The function locks the touch-control keys to prevent unwanted activation.



AUTOMATICALLY SAFETY SWITCH OFF

The cooking zone will switch off automatically after a maximum preset time if the zone is switched on and no further operation is performed.



HB AV 231 A
30CM RADIANT DOMINO HOB

2 Radiant Zones

- Front: 1.8kW
- Rear: 1.2kW

Total Power: 3.0kW

13 Amp / 220~240V/50Hz

Product Size: W290 x D520 x H50mm

Cut-out Size: W270 x D490mm

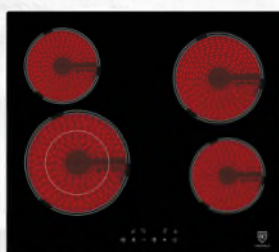

HB AV 461 A
60CM RADIANT CERAMIC HOB

4 Radiant Zones with 1 Dual Zone

- Front Left: 1.1kW to 2.2kW
- Front Right and Rear Left: 1.2kW
- Rear Right: 1.8kW

Total Power: 6.4kW

28 Amp / 220~240V/50Hz

Product Size: W590 x D520 x H50mm

Cut-Out Size: W560 x D490mm



HB AV 271 A
70CM RADIANT CERAMIC HOB

2 Radiant Zones with Dual Zone

- Left and Right: 1.1kW to 2.2kW

Total Power: 3.3kW (Max)

15 Amp / 220~240V/50Hz

Product Size: W730 x D420 x H50mm

Cut-Out Size: W680 x D380mm



GAS HOBS

Our gas hob range will change the way you cook. Unleash your creativity to achieve great tasting food. Deliver perfect cooking results every time, with EF gas hobs. All EF Gas Hobs are equipped with Flame Failure Device. If the burner accidentally goes out, the Safety Valve will automatically cut off gas flow.



GAS HOB

VS

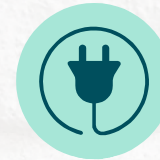

ELECTRIC HOB

ENERGY

Gas supply is required, either LPG or Town Gas.



Electricity supply is required.

HEATING

High flame power produces 'wok hei' flavours. Low and high heating controls.



Precise heating control with specified levels. e.g. level 1 to 9

SAFETY

Equipped with Flame Failure Device. Presence of naked flame.



Child lock option. Absence of naked flame.

COOKWARE

All types of cookware, including woks, may be used.



Only selected types of cookware may be used, and must be flat bottomed.

CONTROL

Low and high heating control options.



Precise heating control with specified levels.

EASE TO CLEAN

Easy to clean with fully sealed burner base.



Easier to clean and wipe across flat glass surface. Absence of burner and knobs.

PRICE

Gas hobs are generally less expensive.



Electric hobs usually come with a higher price point.



BEST OF BOTH WORLDS

Do you ever dream of combining the benefits of electric and gas hobs? EF Domino hobs are the answer. They can be arranged entirely to suit your preferences and go together perfectly in terms of looks. Now you can enjoy the freedom to choose. Perfect for the adventurous home Chefs.

Are you a fan of Asian cuisine?

Simply add a gas burner next to your electric hob.

Achieve 'wok hei' flavours with the flexibility to use all types of cookware.



HB AG 3010 TN VGB 30CM DOMINO GAS HOB

- 1 Burner:
- Triple Ring Burner - 3.4kW
- Cast Iron Pan Supports with Wok Adapter
Product Size: W294 x D510 x H50mm
Cut-Out Size: W266 x D478mm



HB AG 3020 TN VGB 30CM DOMINO GAS HOB

- 2 Burners:
- Front: Semi Rapid Burner - 1.75kW
 - Rear: Rapid Burner - 3.0kW
- Cast Iron Pan Supports
Product Size: W294 x D510 x H50mm
Cut-Out Size: W266 x D478mm

COMMON FEATURES

- 1 FULLY SEALED BURNER BASE
- 2 BATTERY IGNITION (DC 1.5V)
- 3 FLAME FAILURE SAFETY DEVICES
- 4 BLACK TEMPERED GLASS

GAS HOBs - DOMINO





COOK AT HOME WITHOUT LIMITS



EFH 7620 TN VGB 73CM GAS HOB

2 Burners:

- Left: Triple Ring Burner - 3.4kW
- Right: Triple Ring Burner - 3.4kW

Product Size: W730 x D420 x H60mm

Cut-Out Size: W660 x D360mm



EFH 7630 TN VGB 73CM GAS HOB

3 Burners:

- Left and Right: Triple Ring Burner - 3.4kW
- Center: Semi Rapid Burner - 1.75kW

Product Size: W730 x D420 x H60mm

Cut-Out Size: W660 x D360mm

GAS HOBS - GLASS

COMMON FEATURES

1 CAST IRON PAN SUPPORTS WITH WOK ADAPTER

2 FULLY SEALED BURNER BASE

3 BATTERY IGNITION (DC 1.5V)

4 FLAME FAILURE SAFETY DEVICES

5 BLACK TEMPERED GLASS





**EFH 9720 TN VGB
86CM GAS HOB**

2 Burners:

- Left: Triple Ring Burner - 3.4kW
- Right: Triple Ring Burner - 3.4kW

Product Size: W860 x D500 x H60mm

Cut-Out Size: W722~W810 x D428~D460mm



**EFH 9730 TN VGB
86CM GAS HOB**

3 Burners:

- Left and Right: Triple Ring Burner - 3.4kW
- Center: Semi Rapid Burner - 1.75kW

Product Size: W860 x D500 x H60mm

Cut-Out Size: W722~W810 x D428~D460mm

COMMON FEATURES

1 CAST IRON PAN SUPPORTS WITH WOK ADAPTER

2 FULLY SEALED BURNER BASE

3 BATTERY IGNITION (DC 1.5V)

4 FLAME FAILURE SAFETY DEVICES

5 BLACK TEMPERED GLASS





ENABLE THE CHEF IN YOU



HB AG 130 VS A 30CM DOMINO GAS HOB

Single Sabaf Bumer:
Triple Ring Bumer - 3.4kW
220~240V/50Hz
Cast Iron Pan Supports
with Wok Adapter
Product Size:
W300 x D510 x H50mm
Cut-Out Size: W280 x D490mm



HB AG 230 VS A 30CM DOMINO GAS HOB

2 Sabaf Bumers:

- Front: Auxiliary Bumer - 1.0kW
- Rear: Rapid Bumer - 3.0kW

 220~240V/50Hz
Cast Iron Pan Supports
Product Size:
W300 x D510 x H50mm
Cut-Out Size: W280 x D490mm



HB AG 360 VS A 58CM GAS HOB

3 Sabaf Bumers:

- Left: Triple Ring Bumer - 3.4kW
- Right (Front and Rear):
Semi Rapid Bumer - 1.75kW

 220~240V/50Hz
Cast Iron Pan Supports
with Wok Adapter
Product Size:
W580 x D510 x H50mm
Cut-Out Size: W560 x D490mm

GAS HOBS - STAINLESS STEEL

COMMON FEATURES

1

FULLY SEALED
BURNER BASE

2

ELECTRIC IGNITION

3

FLAME FAILURE
SAFETY DEVICES

4

STAINLESS
STEEL



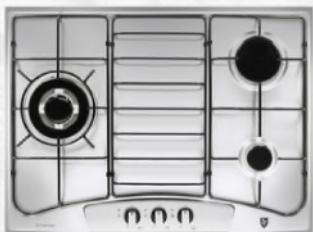

**EFH 3760 TN VSB
68CM GAS HOB**

3 Burners:

- Left: Triple Ring Bumer - 3.4kW
- Front Right: Auxiliary Bumer - 1.0kW
- Rear Right: Rapid Bumer - 3.0kW

Enamelled Pan Support with Wok Adapter

Product Size:

W680 x D500 x H60mm

Cut-Out Size: W552 x D470mm

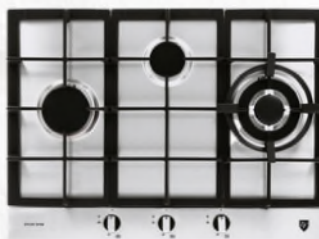

**EFH 3761 TN VSB
68CM GAS HOB**

3 Burners:

- Left: Semi Rapid Bumer - 3.0kW
- Center: Rapid Bumer - 1.75kW
- Right: Triple Ring Bumer - 3.4kW

Cast Iron Pan Supports with Wok Adapter

Product Size:

W680 x D500 x H60mm

Cut-Out Size: W552 x D470mm

COMMON FEATURES

1

FULLY SEALED
BURNER BASE

2

BATTERY IGNITION
(DC 1.5V)

3

FLAME FAILURE
SAFETY DEVICES

4

STAINLESS
STEEL

GAS HOBS - STAINLESS STEEL





CELEBRATE THE DYNAMISM

EF gas hobs make cleaning a breeze.

Incorporating ergonomic design and practical features.

Equipped with fully sealed burner base, any spills are contained.

Enjoy fuss free cleaning!



**EFH 2760 TN VSB
78CM GAS HOB**

2 Burners:

- Left & Right:
Triple Ring Burner - 3.4kW

Product Size:
W780 x D450 x H60mm
Flexible Cut-Out Size:
W660~W750 x D360~D420mm



**EFH 3762 TN VSB
78CM GAS HOB**

3 Burners:

- Left:
Triple Ring Burner - 3.4kW
- Front Right:
Semi Rapid Burner - 1.75kW
- Rear Right:
Auxiliary Burner - 1.0kW

Product Size:
W780 x D450 x H60mm
Flexible Cut-Out Size:
W660~W750 x D360~D420mm

GAS HOBS - STAINLESS STEEL

COMMON FEATURES

1

CAST IRON PAN SUPPORTS WITH WOK ADAPTER

2

FULLY SEALED BURNER BASE

3

BATTERY IGNITION (DC 1.5V)

4

FLAME FAILURE SAFETY DEVICES

5

STAINLESS STEEL





**EFH 3763 TN VSB
78CM GAS HOB**

3 Burners:

- Left:
Triple Ring Burner - 3.4kW
- Center:
Semi Rapid Burner - 1.75kW
- Right:
Triple Ring Burner - 3.4kW

Product Size:

W780 x D450 x H60mm

Flexible Cut-Out Size:

W660~W750 x D360~D420mm



**EFH 3970 TN VSB
86CM GAS HOB**

3 Burners:

- Left:
Triple Ring Burner - 3.4kW
- Front Right:
Rapid Burner - 3.0kW
- Rear Right:
Semi Rapid Burner - 1.75kW

Product Size:

W860 x D500 x H60mm

Flexible Cut-Out Size:

W722~W840 x D428~D480mm



**EFH 3971 TN VSB
86CM GAS HOB**

3 Burners:

- Left:
Triple Ring Burner - 3.4kW
- Center:
Semi Rapid Burner - 1.75kW
- Right:
Triple Ring Burner - 3.4kW

Product Size:

W860 x D500 x H60mm

Flexible Cut-Out Size:

W722~W840 x D428~D480mm

COMMON FEATURES

1

CAST IRON PAN SUPPORTS
WITH WOK ADAPTER

2

FULLY SEALED
BURNER BASE

3

BATTERY IGNITION
(DC 1.5V)

4

FLAME FAILURE
SAFETY DEVICES

5

STAINLESS
STEEL



DUAL FLAME CONTROL HOBS



HIGH FLAME INTENSITY

Experience enhanced flavors a.k.a. iconic "wok hei" with powerful burners offering maximum power up to 5kW (LPG)



TRIPLE RING BURNER

Achieve better heat distribution and a uniform cooking of the food.



PRECISE HEAT CONTROL

On low heating, the inner ring produces a smaller flame suitable for slow cooking and simmering. By adjusting the knob to high heating, the extended rings of flame produce a bigger flame for rapid boiling and frying.



EFH 7626 WT VGB 78CM GAS HOB

2 Brass Burners:

- Left and Right:
Wok Bumer - 5.0kW (LPG)

Product Size:

W780 x D460 x H80 mm

Flexible Cut-Out Size:

W650~W725 x D350~D415 x

R120mm



EFH 7635 WT VGB 78CM GAS HOB

3 Brass Burners:

- Left and Right:
Wok Bumer - 5.0kW (LPG)
- Center:
Semi Rapid Burner - 2.0kW

Product Size:

W780 x D460 x H80 mm

Flexible Cut-Out Size:

W650~W725 x D350~D415 x

R120mm



EFH 9733 WT VGB 86CM GAS HOB

3 Brass Burners:

- Left and Right:
Wok Bumer - 5.0kW (LPG)
- Center:
Semi Rapid Burner - 2.0kW

Product Size:

W860 x D510 x H80mm

Flexible Cut-Out Size:

W700~W810 x D400~D450mm,

R120mm

COMMON FEATURES

1

CAST IRON PAN SUPPORTS WITH INEGRATED WOK STAND

2

FULLY SEALED BURNER BASE

3

BATTERY IGNITION (DC 1.5V)

4

FLAME FAILURE SAFETY DEVICES

5

BLACK TEMPERED GLASS

6

DUAL FLAME CONTROL



EXPERIENCE THE POWER

Revolutionize the way you cook and create flavorful dishes right at home with the powerful performance and efficiency of EF Dual Flame Control Hobs.



EFH 2763 WT VSB 76CM GAS HOB

2 Brass Burners:

- Left and Right:
Wok Burner - 5.0kW (LPG)

Product Size:

W760 x D450 x H78mm

Flexible Cut-Out Size:

W650~W725 x D350~D415,
R120mm



EFH 3767 WT VSB 76CM GAS HOB

3 Brass Burners:

- Left and Right:
Wok Burner - 5.0kW (LPG)
- Center:
Semi Rapid Burner - 2.0kW

Product Size:

W760 x D450 x H78mm

Flexible Cut-Out Size:

W650~W725 x D350~D415,
R120mm



EFH 3976 WT VSB 86CM GAS HOB

3 Brass Burners:

- Left and Right:
Wok Burner - 5.0kW (LPG)
- Center:
Semi Rapid Burner - 2.0kW

Product Size:

W860 x D510 x H78mm

Flexible Cut-Out Size:

W700~W810 x D400~D450mm,
R120mm

COMMON FEATURES

1

CAST IRON PAN SUPPORTS
WITH INEGRATED WOK STAND

2

FULLY SEALED
BURNER BASE

3

BATTERY IGNITION
(DC 1.5V)

4

FLAME FAILURE
SAFETY DEVICES

5

STAINLESS
STEEL

6

DUAL FLAME
CONTROL

FLUSH DESIGN GAS HOBS



MINIMAL THICKNESS 1.8mm



HIGH GRADE 304 STAINLESS STEEL



RECESSED BURNERS



**HB FG 3060 TN VSB
60CM GAS HOB**

3 Burners

- Rear Left:
Semi Rapid Bumer - 1.75kW
- Front Left:
Rapid burner - 3.0 kW
- Right:
Triple Ring Bumer - 3.4kW

Product Size:

W580 x D500 x H80mm

Cut-Out Size: W563 x D483mm



**HB FG 3070 TN VSB
72CM GAS HOB**

3 Burners

- Rear Left:
Semi Rapid Bumer - 1.75kW
- Front Left:
Rapid burner - 3.0 kW
- Right:
Triple Ring Bumer - 3.4kW

Product Size:

W720 x D500 x H80mm

Cut-Out Size: W703 x D483mm



**HB FG 4090 TN VSB
87CM GAS HOB**

4 Burners

- Rear (Left & Right):
Semi Rapid Bumer - 1.75kW
- Front Right:
Rapid Bumer - 3.0kW
- Front Left:
Triple Ring Bumer - 3.4kW

Product Size:

W870 x D500 x H80mm

Cut-Out Size: W853 x D483mm

COMMON FEATURES

1 CAST IRON PAN SUPPORTS WITH WOK ADAPTER

2 FULLY SEALED BURNER BASE

3 BATTERY IGNITION (DC 1.5V)

4 FLAME FAILURE SAFETY DEVICES

5 STAINLESS STEEL

6 FLUSH DESIGN

MINIMAL THICKNESS 1.8mm

Beautifully Blends into Kitchen Countertop for Seamless Finishing. Easily Move Cookware Across Integrated Flat Surface.

HIGH GRADE 304 STAINLESS STEEL

Classic Stainless Steel Presents Timeless Kitchen Design While Delivering Reliable and Durable Performance

RECESSED BURNERS

Minimizes Wind Interruptions and Heat Loss to the Surrounding. Consistent Flame Heating for Perfect Cooking Results.

WHAT IS FLUSH DESIGN?



FLUSH DESIGN GAS HOBS



OTHER GAS HOBS





COOKER HOODS

Cook in comfort at home. EF curates a range of modern cooker hoods that are not only aesthetically pleasing, they are quiet, high performance and made to last.



COOKER HOODS



COOKER HOOD IS ESSENTIAL.



LESS HEAT & ODOUR COOK IN COMFORT

Cooking produces a large amount of smoke, steam and smell that build up over time in the kitchen, hence making it stuffy and unbearable. EF cooker hoods are the solution to your needs.



CLEANER AIR, BETTER HEALTH

Along with smoke and steam, there are harmful air pollutants such as carbon monoxide and grease particles that may be inhaled. A cooker hood will eliminate them at home.



BETTER KITCHEN LIGHTING

Reduce chances of burning with enhanced visibility, thanks to built in hood lights that illuminate as you cook. Helps with cleaning corners or blind spots.

CHOOSING THE RIGHT HOOD



How do you determine the ideal suction power for your kitchen? Let us help you.

Calculate your kitchen area by multiplying the width, depth and height, and then multiply it by 10.

As a general guide, your cooker hood is expected to replace the air in your kitchen by minimally 10 times per hour. The result would be the minimum suction power in cubic meter per hour.

$$\text{Min. Extraction Rate (m}^3\text{/h)} = \frac{(W \times D \times H) \times 10}{3}$$



Did you know?

A minimum safety distance is required between your cooker hood and hob.

Min. 650mm (Electric hob)

Min. 700mm (Gas hob)

The size of your hood should also be equal to or greater than the size of your hob.

COOKER HOODS

From stunning centrepieces to discreetly functional models, the aesthetics of EF cooker hoods complement our other kitchen appliances. Save time and effort on cleaning with ergonomic design and features that effectively eliminate oil, smoke and odors from your kitchen.



EXTRACTION MODE

Smoke and steam are passed through the hood and discharged outside the home via the ducted pipes. Grease and odours are effectively removed. Installation tends to be more complicated as ducting is required, thus suitable for larger homes with more spacious kitchens.



RECIRCULATION MODE

Smoke and steam are passed through grease and charcoal filters in the hood and clean air is returned back into the kitchen. The filters effectively remove grease particles and odours from the air. Ducting is not required, thus suitable for installation in smaller apartments and HDB units.



SENSOR TOUCH CONTROL

Enjoy greater convenience at your fingertips. Elegant Sensor Touch Control is user friendly and easy to select, allowing you to quickly switch between modes and settings. Doubling as a centerpiece, it beautifies your kitchen by seamlessly integrating into your home. Enjoy fuss free cleaning with a swift wipe across the panel.



TRIPLE MOTORS

Form meets functionality with EF high efficiency motors series of slim hoods that provide exceptional airflow rate of up to 825m³/hr. Offering high performance in removing smoke and grease from your kitchen, enjoy a comfortable cooking experience with optimal air quality at home.



TIME DELAY

Enjoy peace of mind without worrying about lingering smoke and smell at home! Simply select the Delay Stop function to let the cooker hood run for an additional 15mins after cooking to thoroughly remove any residual heat and grease in the air. Cooker hood automatically switches off after the preset duration.



LED LIGHTS

Save more, buy less. LED lights last up to 50 times longer than halogen bulbs, while offering up to 12 times better energy efficiency, thus allowing greater utility savings and reducing frequency of replacements. Emitting a mere 10% of their energy in heat, LED lights remain cool to the touch and reduce risks of accidental scalding.



COOKER HOODS





ISLAND HOOD

Designed to be suspended over a central cooking island, Island Hoods create a dynamic focal point in the kitchen. Equipped with powerful suction power to effectively remove smoke, steam and odour even in an open concept kitchen.



GESTURE CONTROL

Novel Sensor Touch Control with Gesture Sensors adjust fan speed or switch on/off the hood settings with a simple hand gesture across the control panel. Gesture right to increase speed, gesture left to decrease speed.



AIR IONIZER

Built-in Ioniser helps to neutralize and sanitize air by deactivating viruses, bacteria and allergens. Provides a pleasant and comfortable cooking environment at home.

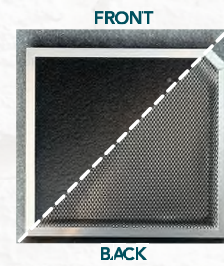

CHARCOAL FILTER

2-in-1 charcoal comes with an additional layer of grease filter. Effectively filters out smells, purifies air and prevents unpleasant odours. Keeping your kitchen smelling fresh.

ISLAND HOOD



CK LUNA IS 90CM ISLAND HOOD

Sensor Touch Control with Gesture Control
Air Ionizer
3 Fan Speeds
2-in-1 Charcoal Filter
2 x Aluminum Filters
Stainless Steel with Black Tempered Glass Panel
Time Delay Function
LED Light Panel
Max. Extraction Rate: 1200m³/hr
Recirculation and Extraction Mode
Dimensions: W900 x D600 x H600~1100mm



CHIMNEY HOODS

Designed to be a statement piece in the kitchen whilst offering various styles and widths to suit your kitchen, Chimney Hoods both perform well and please the eye. Mount it on the wall for complete freedom in your kitchen planning.



CK VISTA 90CM WALL MOUNTED CHIMNEY HOOD

- Sensor Touch Control with Gesture Control
- Air Ionizer
- 3 Fan Speeds
- Single Charcoal Filter
- 2 x Baffle Filters, 1 x Oil Tray
- Stainless Steel with Black Tempered Glass Panel
- Time Delay Function
- 2 x 2W LED Light
- Max. Extraction Rate: 1200m³/hr
- Recirculation and Extraction Mode
- Product Size: W900 x D505 x H492~972mm



CK FINO PLUS BK 90CM WALL MOUNTED CHIMNEY HOOD

- Sensor Touch Control
- 4 Fan Speeds
- Dual Charcoal Filters
- Triple Aluminium Filters
- Full Black with Black Acrylic Panel
- Time Delay Function
- 2 x 2W LED Lights
- Max. Extraction Rate: 1000m³/hr
- Recirculation and Extraction Mode
- Product Size: W900 x D480 x H547-1040mm



CHIMNEY HOODS



YOUR KITCHEN IS HEART OF HOME

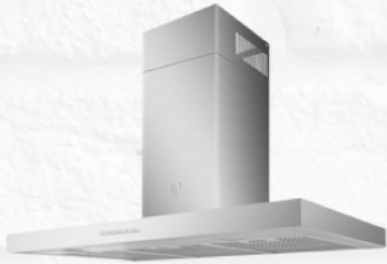

CK FINO 55 90CM WALL MOUNTED CHIMNEY HOOD

Electronic Control
4 Fan Speeds
Dual Charcoal Filters
Triple Aluminium Grease Filters
Time Delay Function
2 x 2W LED Lights
Max. Extraction Rate : 1000m³/hr
Recirculation and Extraction Mode
Product Size: W900 x D480 x H542~1030mm



CK MIA 60 60CM WALL MOUNTED CHIMNEY HOOD

Push Control
3 Fan Speeds
Single Charcoal Filter
Dual Aluminium Grease Filters
2 x 20W Halogen Lights
Max. Extraction Rate: 900m³/hr
Recirculation and Extraction Mode
Product Size: W600 x D480 x H650~1070mm

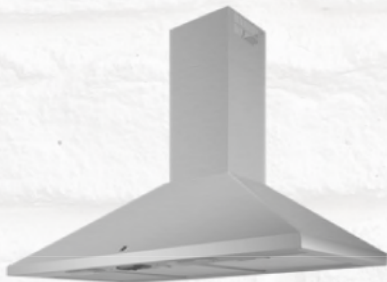

CK PREMIO 60 60CM WALL MOUNTED CHIMNEY HOOD

Slide Control
3 Fan Speeds
Dual Charcoal Filters
Dual Aluminium Grease Filters
2 x 40W Bulbs
Max. Extraction Rate: 750m³/hr
Recirculation and Extraction Mode
Product Size: W600 x D515 x H772~972mm





TIMELESS DESIGN

Cooker hoods play an essential role in keeping your home smelling fresh, so you can always enjoy cooking at the comfort of your home. Featuring classic and timeless stainless steel material, our cooker hoods help to create the right kitchen ambience while complementing your kitchen design beautifully.

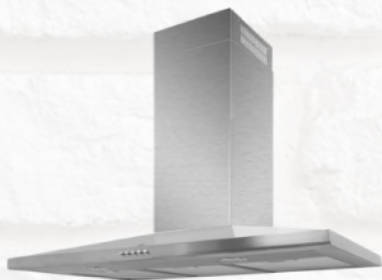

MADE IN ITALY

CK MIA 90 **90CM WALL MOUNTED CHIMNEY HOOD**

Push Control
3 Fan Speeds
Single Charcoal Filter
Triple Aluminium Grease Filters
2 x 20W Halogen Lights
Max. Extraction Rate: 900m³/hr
Recirculation and Extraction Mode
Product Size: W900 x D480 x H650~1070mm



MADE IN ITALY

CK PREMIO 90 **90CM WALL MOUNTED CHIMNEY HOOD**

Slide Control
3 Fan Speeds
Dual Charcoal Filters
Triple Aluminium Grease Filters
2 x 40W Bulbs
Max. Extraction Rate: 750m³/hr
Recirculation and Extraction Mode
Product Size: W900 x D515 x H772~972mm



CHIMNEY HOODS



YOUR KITCHEN, YOUR RULES.



MADE IN ITALY

CK STILE

90CM WALL MOUNTED CHIMNEY HOOD

Push Button Control
3 Fan Speeds
Single Charcoal Filter
Single Aluminium Grease Filter
Tempered Glass
2 x 20W Halogen Lights
Max. Extraction Rate: 1200m³/hr
Recirculation and Extraction Mode
Product Size: W900 x D520 x H650~1070mm

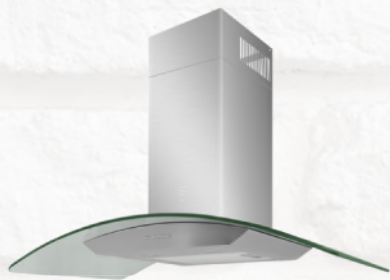

CK VETRO PLUS

90CM WALL MOUNTED CHIMNEY HOOD

Electronic Control
4 Fan Speeds
Dual Charcoal Filters
Single Aluminium Grease Filter
Curve Tempered Glass
Time Delay
2 x 20W Halogen Lights
Max. Extraction Rate: 1200m³/hr
Recirculation and Extraction Mode
Product Size: W900 x D480 x H500~900mm



CH AG30 A

90CM WALL MOUNTED CHIMNEY HOOD

LCD Sensor Touch Control
4 Fan Speeds
Single Charcoal Filter
Single Aluminium Grease Filter
Tempered Glass
Time Delay
2 x 20W Halogen Lights
Max. Extraction Rate: 1000m³/hr
Recirculation and Extraction Mode
Product Size: W900 x D436 x H857~1332mm



SLIM HOODS

Designed to fit underneath the kitchen wall cabinets neatly; Slim Hoods are the perfect solution for space constraint apartments. Featuring compact body and powerful performance, EF Slim Hoods effectively remove grease, smoke and steam produced during cooking to keep your air at home fresh and clean.



EFCH 6101 HM SSL 60CM SLIM HOOD

- Push Button Control
- 3 Fan Speeds
- Dual Charcoal Filters
- 2 x Aluminium Grease Filters
- 2 x 2W LED Lights
- Stainless Steel
- Max. Extraction Rate: 480m³/hr
- Recirculation and Extraction Mode
- Product Size: W600 x D495 x H140mm



EFCH 9101 HM SSL 90CM SLIM HOOD

- Push Button Control
- 3 Fan Speeds
- Dual Charcoal Filters
- 3 x Aluminium Grease Filters
- 2 x 2W LED Lights
- Stainless Steel
- Max. Extraction Rate: 480m³/hr
- Recirculation and Extraction Mode
- Product Size: W900 x D495 x H140mm



SLIM HOODS





ELEGANT DESIGN FOR YOUR KITCHEN



EFCH 9103T SS 90CM SLIM HOOD

Push Button Control
3 Fan Speeds
Dual Charcoal Filters
3 x Aluminum Grease Filters
2 x 2W LED Lights
Stainless Steel
Max. Extraction Rate: 480m³/hr
Recirculation and Extraction Mode
Product Size: W895 x D480 x H100mm



EFCH 9108T BK 90CM SLIM HOOD

Push Button Control
3 Fan Speeds
Dual Charcoal Filters
3 x Aluminum Grease Filters
2 x 2W LED Lights
Full Matte Black
Max. Extraction Rate: 480m³/hr
Recirculation and Extraction Mode
Product Size: W895 x D480 x H100mm



SLIM HOODS



SEMI INTEGRATED HOODS

Designed with easy to reach front controls, Semi Integrated Hoods are installed almost concealed within your kitchen cabinets with only the control panel visible. Presenting a minimalistic look, they are a perfect fit for your kitchen design.



EFCH 6201 HM SSL 60CM SEMI INTEGRATED HOOD

- Push Button Control
- 3 Fan Speeds
- Dual Charcoal Filters
- 2 x Aluminium Grease Filters
- 2 x 2W LED Lights
- Stainless Steel
- Max. Air Flow Rate: 550m³/hr
- Recirculation Mode Only
- Product Size: W600 x D420 x H70+50mm



EFCH 6202 HM SSL 60CM SEMI INTEGRATED HOOD

- Push Button Control
- 3 Fan Speeds
- Dual Charcoal Filters
- 2 x Aluminium Grease Filters
- 2 x 2W LED Lights
- Stainless Steel With Black Acrylic Panel
- Max. Air Flow Rate: 550m³/hr
- Recirculation Mode Only
- Product Size: W600 x D420 x H70+50mm



FRESH BREEZE FUNCTIONALITY



EFCH 9201T SS 90CM SEMI INTEGRATED HOOD

Push Button Control
3 Fan Speeds
Dual Charcoal Filters
3 x Aluminum Grease Filters
2 x 2W LED Lights
Stainless Steel
Max. Air Flow Rate: 550m³/hr
Recirculation Mode Only
Product Size: W895 x D420 x H70+50mm



EFCH 9202T BK 90CM SEMI INTEGRATED HOOD

Push Button Control
3 Fan Speeds
Dual Charcoal Filters
3 x Aluminum Grease Filters
2 x 2W LED Lights
Matte Black with Black Acrylic Panel
Max. Air Flow Rate: 550m³/hr
Recirculation Mode Only
Product Size: W895 x D420 x H70+50mm



EFCH 9204T BK 90CM SEMI INTEGRATED HOOD

Invisible Touch Control
3 Fan Speeds
Dual Charcoal Filters
3 x Aluminum Grease Filters
2 x 2W LED Lights
Matte Black with Glass Panel
Max. Air Flow Rate: 550m³/hr
Recirculation Mode Only
Product Size: W895 x D420 x H70+50mm





OIL TRAY HOODS



OIL TRAY HOODS

Equipped with easy-to-remove oil tray that collects oil from the greasy fumes produced during cooking. Simply rinse the trays for for fuss-free cleaning.



EFCH 9111 HM SS 90CM SLIM HOOD

Push Button Control
3 Fan Speeds
Rectifier Panel with Long Oil Tray
Aluminium Filter With Charcoal (2-in-1)
2 x 1W LED Lights
Stainless Steel
Max. Air Flow Rate: 700m³/hr
Recirculation Mode Only
Product Size: W900 x D530 x H140mm



EFCH 9212 HM BK 90CM SEMI INTEGRATED HOOD

Push Button Control
3 Fan Speeds
Dual Motors
Rectifier Panel with Long Oil Tray
Dual Charcoal Filters
2 x 1W LED Lights
Stainless Steel with Black Panel
Max. Air Flow Rate: 700m³/hr
Recirculation Mode Only
Product Size: W900 x D420 x H70+50mm



HIGH SUCTION POWER HOODS

Compact but packed with power; enjoy exceptional performance and superb efficiency with EF triple-motors series of Semi Integrated Hoods. Experience the extraordinary suction power at home. Perfect for Home Chefs.



SENSOR TOUCH CONTROL

Ergonomic sensor touch control panel is easy to reach and user friendly. Quickly adjust fan speeds and select settings with a simple touch. Especially useful for greasy fingers during cooking.

TRIPLE MOTORS

Do you enjoy cooking but dread the clean up? Our triple motor hoods are the perfect solution for you.

Providing remarkable airflow rate of up to 825m³/hr, cook up a storm at home without worrying about the smoke, grease and smell. Heavy duty to handle heavy, oily, and high volume cooking.



CHARCOAL FILTER

Active charcoal filter that effectively filters smells while cooking. , purifies air and prevents unpleasant odours in the kitchen. Keeps your kitchen smelling fresh.

FORM MEETS FUNCTIONALITY



EFCH 9231T SS 90CM SEMI INTEGRATED HOOD

Electronic Switch Control
3 Fan Speeds
Triple Motors
Triple Charcoal Filters
3 x Aluminum Grease Filters
2 x 2W LED Lights
Stainless Steel
Max. Air Flow Rate: 825m³/hr
Recirculation Mode Only
Product Size: W895 x D420 x H70+50mm



EFCH 9234T BK 90CM SEMI INTEGRATED HOOD

Sensor Touch Control
3 Fan Speeds
Triple Motors
Triple Charcoal Filters
3 x Aluminum Grease Filters
Time Delay Function
2 x 2W LED Light
Matte Black with Glass Panel
Max. Air Flow Rate: 825m³/hr
Recirculation Mode Only
Product Size: W895 x D420 x H70+50mm



EFCH 9236T BK 90CM SEMI INTEGRATED HOOD

Push Button Control
3 Fan Speeds
Triple Motors
Triple Charcoal Filters
3 x Aluminum Grease Filters
2 x 2W LED Lights
Matte Black with Black Acrylic Panel
Max. Air Flow Rate: 825m³/hr
Recirculation Mode Only
Product Size: W895 x D420 x H70+50mm

POWER SLIM HOODS

Splendid suction power made possible thanks to powerful motor. Cook to your hearts content without worrying about clean ups.

Greasy smoke and steam will be effectively filtered, ensuring optimal air quality, preventing oily build up, and reducing cleaning time. Do you enjoy deep frying, or cooking many dishes simultaneously? EF Power Slim hoods are made for you.

Enjoy less time for cleaning, and more time for family.



HIGH SUCTION POWER HOODS





EXTRAORDINARY PERFORMANCE



POWER SLIM 90 SSL 90CM SEMI INTEGRATED HOOD

- Push Button Control
- 3 Fan Speeds
- Single Motor
- Dual Charcoal Filters
- Triple Aluminium Grease Filters
- 2 x 2.5W LED Light
- Stainless Steel
- Max. Air Flow Rate: 1000m³/hr
- Recirculation Mode Only
- Product Size: W900 x D420 x H225+50mm



POWER SLIM 90 X/VL 90CM SEMI INTEGRATED HOOD

- Push Button Control
- 3 Fan Speeds
- Single Motor
- Dual Charcoal Filters
- Triple Aluminium Grease Filters
- 2 x 2.5W LED Lights
- Stainless Steel With Black Acrylic Panel
- Max. Air Flow Rate: 1000m³/hr
- Recirculation Mode Only
- Product Size: W900 x D420 x H225+50mm

HIGH SUCTION POWER HOODS



TELESCOPIC HOODS

Ergonomic design slides out to extend over the cooking area when needed, and retracts to be fully concealed when not in use.

Absence of control panel allows the cooker hood to seamlessly integrate with your kitchen cabinets to blend into your interior design.

Perfect for minimalistic and modern kitchen design.



FLUSH SEAMLESSLY, WORK EFFORTLESSLY.



EFCH 9401 HM SS 90CM TELESCOPIC HOOD

Slide-Out Control
2 Fan Speeds
Dual Charcoal Filters
Dual Aluminium Grease Filters
2 x 40W Bulbs
Front Ventilation
Stainless Steel
Max. Air Flow Rate: 580m³/hr
Recirculation Mode Only
Product Size: W900 x D280-435 x H140+40mm



EFCH 9402 AL 90CM TELESCOPIC HOOD

Slide-Out Control
3 Fan Speeds
Dual Charcoal Filters
Dual Aluminium Grease Filters
2 x 40W Bulb
Front Ventilation
Stainless Steel With Black Acrylic Panel
Max. Extraction Rate: 600m³/hr
Recirculation and Extraction Mode
Product Size: W900 x D280-435 x H135+40mm



TF 5293/90 90CM TELESCOPIC HOOD

Slide-Out Control
2 Fan Speeds
Dual Charcoal Filters
Dual Aluminium Grease Filters
2 x 40W Bulb
Max. Extraction Rate: 550m³/hr
Extraction Mode
Product Size: W898 x D280 x H140+45mm

BUILT-IN OVENS

Incorporating state of the art technology and timeless design, EF ovens are thoughtfully produced to ensure high quality standards. Experience remarkable performance and superb convenience at home.

BO GE 1770 SA M
60CM STEAM + CONVECTION COMBI OVEN

BUILT-IN OVENS



BUILT-IN OVENS

Achieve perfect cooking results effortlessly with EF ovens! Equipped with ergonomic features, now you may enjoy peace of mind and fuss-free cleaning to complement your busy lifestyle.



SENSOR TOUCH CONTROL

Intuitive sensor touch control simplifies cooking. Easily adjust oven settings with a touch. The electronic display guides you through cooking options for precise control.



TRIPLE GLAZED GLASS DOOR

Triple glazed glass door offers optimal heat insulation and easy cleaning. The three glass panels can be removed for cleaning.



PUSH IN POP OUT KNOB WITH LED LIGHT

Elegantly designed with led light, with the push in pop out knob, cleaning is such a breeze.



5 SHELF POSITIONS WITH EASY DETACHABLE SIDE RACKS

Flexibility for multi-cooking on different shelves simultaneously, saving time and energy. Varying heating results based on shelf level; higher racks brown top, lower racks brown bottom.

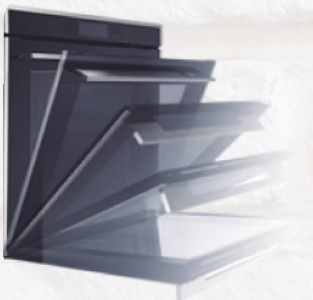

SOFT CLOSE DOOR SYSTEM

With the latest innovative soft close door hinge, with just a light touch, closing oven door is elegant, silent and effortless.

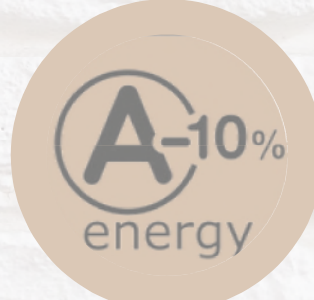

A-10% ENERGY EFFICIENCY

EF ovens are well insulated, promoting heat retention for faster cooking and improved A-10% energy efficiency.



LARGER CAPACITY

Ovens with 73 litres cavity volume offer spaciousness, providing flexibility to cook simultaneously on different shelves, reducing cooking time. They can accommodate whole chickens or turkeys at home.



AUTO SAFETY SWITCH OFF

The oven will switch off automatically if the oven is left on for a long period of time.



3D HEATER FAN

Evenly distributes and cooks by suppressing heat transfer to surroundings



CHILD LOCK

The function locks the touch-control keys against unwanted activation. Safe for your curious little ones at home.

BUILT-IN OVENS





PRECISION MEETS VERSATILITY

BO GE 1770 SA M 60CM STEAM + CONVECTION COMBI OVEN

Steaming is one of the best cooking methods for preserving nutrients in food, including water-soluble vitamins which are sensitive to heat and water.

Prepare healthy and nutritious homecooked meals with convenience at home thanks to combi steam oven.

Choose from Steam Assist functions to bake and cook with added steam, so foods turn out crispy on the outside and juicy on the inside.

Select Pure Steam for convenience of steaming large portions of whole chicken or fish in the oven.

- 17 Functions (Full Steam Function and Steam + Convection Functions)
- 25 Automatic Menus
- Automatic Cut Off Timer
- Child Lock, Power Saving Mode
- Drying and Descaling Functions
- A-10% Class in Energy Efficiency
- Cavity volume: 72 litres
- Max. Temperature: 250°C
- Total Power Load: 3.2kW
- Accessories: Wire Rack, Baking Tray, Steam Tray, Meat Probe
- Product Size: W594 x D569 x H594mm
- Cut-Out: W565 x D550 x H585mm

STEAM COMBI OVEN



Sensor Touch Control



3D Fan: Even Heating



5 Shelf Positions & Side Racks



Triple Glazed Glass Door



Large Cavity 72 Litres



17 Functions



25 Automatic Menus



Drying & Descaling



Water Tank



Meat Probe



17 FUNCTIONS



CONVENTIONAL



For traditional baking and roasting on one level. Especially suitable for cakes with moist toppings.



CONVECTION



For traditional baking and roasting on one or more levels. Heat evenly circulates around from the ring heater and fan.



DOUBLE GRILL + FAN



For grilling fat items and for browning food. The fan distributes the heat evenly around the cavity.



CONVENTIONAL + FAN



For baking and roasting on one or more levels. The fan distributes heat evenly around the oven.



FULL GRILL



For grilling small amounts of food and for browning food. Place food under the grill heating element.



BOTTOM HEAT



For adding extra browning to the bases of pizzas, pies, and pastries. Heating comes from the bottom.



DOUGH PROOFING



For making yeast dough and sourdough to proof, and culture yogurt.



DRYING FUNCTION



It is used to dry the furnace chamber and prevent bacteria from growing.



ECO



For energy saving cooking.



PURE STEAM



For steaming of all kinds of food, including vegetables, meat, whole fish and chicken. Steam function operates at 100%.



CONVENTIONAL + STEAM



For traditional baking and roasting on one level. Especially suitable for cakes with moist toppings.



CONVECTION + STEAM



For baking and roasting on one or more levels. the fan evenly circulates Heat from the ring heater.



CONVENTIONAL+FAN+STEAM



For baking and roasting on one or more levels. The fan distributes heat evenly around the cavity.



BOTTOM HEAT + STEAM



For adding extra browning to the bases of pizzas, pies, and pastries. Heating comes from the bottom.



RADIANT HEAT + STEAM



For grilling small amounts of food and for browning food under the grill heating element.



QUICK PREHEAT



It is used to shorten cooking time. To achieve an even cooking result.

LIGHT





EMBRACE CULINARY EXCELLENCE

Discover the future of cooking convenience - our Microwave Combi Oven! Elevate your culinary experience with cutting-edge technology that combines microwave speed and convection precision.

From reheating to roasting, baking to grilling - this versatile appliance does it all effortlessly. Intuitive controls and pre-programmed settings make gourmet meal preparation a breeze for chefs of all levels.

No more guesswork; our Microwave Combi Oven automatically adjusts power levels and cooking times for perfect results every time. Enjoy convenience without compromising taste.

Explore a world of flavors with sleek, modern design that seamlessly fits into any kitchen, adding sophistication to your space.

Elevate your cooking game and savor every moment. Experience a new level of mastery today!

BO GE 1771MW M 60CM MICROWAVE + CONVECTION COMBI OVEN

- 16 Functions
- 13 Automatic Recipes
- Microwave Function and Microwave + Convection Functions
- Black with Stainless Steel Strip, Mirror Glass
- Sensor Touch Control with Knobs
- 5 Shelf Positions, Easy Detachable Side Racks
- Triple Glazed Glass Door
- Delay Start and Automatic Cut Off Timer
- Child Lock
- Cavity volume: 72 litres
- Max. Temperature: 250°C
- Total Power Load: 2.9kW (13 Amp)
- Rated Output (Microwave): 800W
- Accessories: Wire Rack and Baking Tray
- Product Size: W595 x D566 x H596mm
- Cut-Out Size: W565 x D550 x H585mm

MICROWAVE COMBI OVEN



Sensor Touch Control



3D Fan: Even Heating



5 Shelf Positions & Side Racks



Triple Glazed Glass Door



Large Cavity 72 Litres



16 Functions



13 Automatic Menus



Microwave Function



Microwave + Convection Functions



16 FUNCTIONS



CONVENTIONAL



For traditional baking and roasting on one level. Especially suitable for cakes with moist toppings.

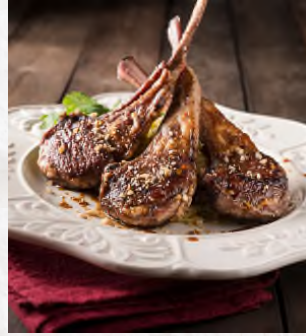

CONVECTION



For traditional baking and roasting on one or more levels. Heat evenly circulates around from the ring heater and fan.



DOUBLE GRILL + FAN



For grilling fat items and for browning food. The fan distributes the heat evenly around the cavity.



CONVENTIONAL + FAN



For baking and roasting on one or more levels. The fan distributes heat evenly around the oven.



FULL GRILL



For grilling small amounts of food and for browning food. Place food under the grill heating element.

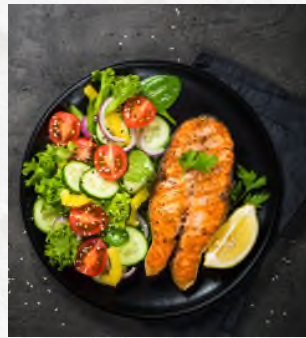

DOUBLE GRILL



For grilling flat items and for browning food.



DOUGH PROOFING



For making yeast dough and sourdough to proof, and culture yogurt.



BOTTOM HEAT



For adding extra browning to the bases of pizzas, pies, and pastries. Heating comes from the bottom.



PIZZA



For pizza and dishes which need a lot of heat from underneath. The bottom heater and ring heater will work.



DEFROST



It is used to shorten cooking time. To achieve an even cooking result.



QUICK PREHEAT



It is used to shorten cooking time. To achieve an even cooking result.



LIGHT



MICROWAVE



BO GE 1771MW M

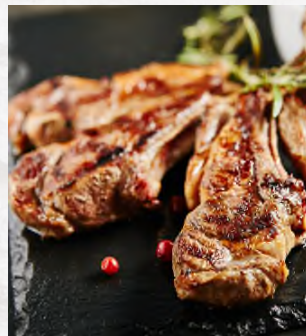

MICROWAVE + CONVECTION



MICROWAVE + DOUBLE GRILL + FAN

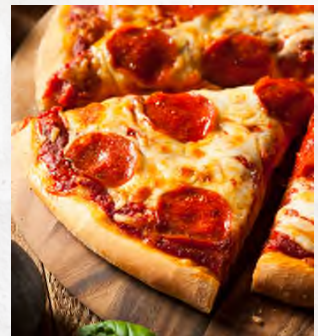

MICROWAVE + PIZZA MODE



MADE FOR ALL YOUR COOKING NEEDS



BO AE 86 A 60CM MULTI-FUNCTION BUILT IN OVEN

8 Functions: Top Heating, Convection, Delicate Cooking, Bake Cooking, Full Grill, Fan Assist Grill, Defrost, Light
Electronic control with digital clock
Automatic cut off timer

Pop out knob with LED light

Max. temperature: 250°C

Total power load: 2.64kW

Accessories: Grill Tray, Baking Tray and Rotisserie

Product Size: W594 x D569 x H594mm

Built In Dimensions: W565 x D550 x H585mm

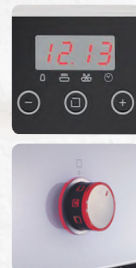

BO AE 63 A 60CM CONVENTIONAL BUILT IN OVEN

6 Functions: Top Heating, Convection, Fan Bake, Fan Assist Grill, Full Grill, Light

Mechanical control

Automatic cut off timer

Max. temperature: 250°C

Total power load: 2.64kW

Accessories: Grill Tray, Baking Tray and Rotisserie

Product Size: W594 x D569 x H594mm

Built In Dimensions: W565 x D550 x H585mm



COMMON FEATURES



- Triple glazed glass door
- Soft Close Door System
- Large Cavity volume: 73 litres
- 5 shelf positions
- A-10% class in energy efficiency
- Automatic cut off timer
- Rotisserie

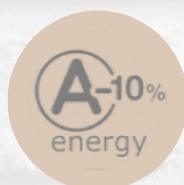



PERFECT FOR THE D.I.Y. HOME CHEF

Enjoy total freedom and full control of the cooking settings with our conventional oven that complement your own unique recipes.



BO AE 62 A

60CM CONVENTIONAL BUILT IN OVEN

6 Functions: Top Heating, Convection, Fan Bake, Full Grill, Fan Assist Grill, Light

Mechanical control

A-class in Energy Efficiency

Cavity volume: 56 litres

Max. temperature: 250 °C

Total power load: 2.64kW

Accessories: Grill Tray, Baking Tray and Rotisserie

Product Size: W594 x D568 x H594mm

Built In Dimensions: W565 x D550 x H585mm



FEATURES



- Triple glazed glass door
- 5 shelf positions
- A-class in energy efficiency
- Automatic Switch Off
- Rotisserie

BUILT-IN OVENS

MICROWAVE OVENS

Enjoy convenience and flexibility at home with EF Multi-function Microwave Ovens. Combining Grill and Microwave functions 2-in-1 to rapidly heat up and cook. Available in built-in and free standing models.

MICROWAVE OVENS



MICROWAVE OVENS FEATURES

Enjoy greater convenience and versatility with EF Microwave Ovens that are multi-function. All EF Ovens are thoughtfully designed to incorporate the following features:

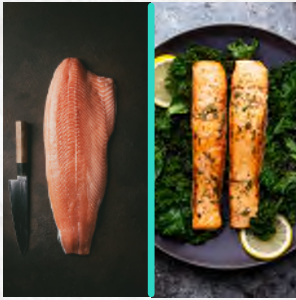

MICROWAVE, GRILL & COMBI FUNCTIONS

Enjoy the convenience of a multifunction microwave oven with powerful built-in grill. The two technologies offer a versatile choice of Microwave, Microwave Grilling, or Full Grill modes. Enabling you to make a variety of dishes using just your EF microwave oven.



5 MICROWAVE POWER LEVELS

Designed with a range of power levels, EF microwave oven gives you the flexibility you need. Enjoy total control over power levels so you may achieve perfectly cooked design every time. Made for all your cooking needs; for different cuisines.



EASY DEFROST

Defrost time is halved when you pop it in the microwave. Select the optimal defrost settings by keying in the weight of food from 100 to 2000 g. Perfect for frozen meats and pre-cooked foods to quickly and easily defrost.



AUTO COOKING MENUS

Access a suite of menu settings with just a push of a button. Explore a variety of recipes settings developed for chicken, fish, beverage, popcorn, and more. Preset settings guarantee the best cooking results. so you can whip up a tasty meal effortlessly at home in less time.



25L CAVITY VOLUME & 95 MINS TIMER

Enjoy a spacious cavity to accommodate your dishes. Prepare a scrumptious meal or delicious snacks and with total freedom. Select timer up to 95 minutes so your meal is piping hot and ready to consume anytime you desire.



FREESTANDING FOR FLEXIBILITY AT HOME

Freedom to use, move, or store away at any suitable place around the home.



EFMO 8925 M FREE STANDING MICROWAVE OVEN WITH GRILL

8 auto cooking menus

Ø 315MM Turntable
LED display

Microwave power: 900W

Grill power: 1000W

Total power load: 1450W

Product Size: W513 x D430 x H306.2mm

RCP: \$259

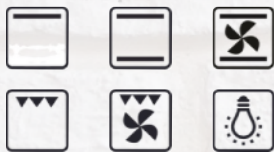

FREESTANDING MICROWAVE OVEN

COMMON FEATURES

1

95 MINUTES TIMER

2

CAVITY VOLUME:
25 LITRES

3

5 MICROWAVE
POWER LEVELS

4

COMBI MICROWAVE GRILLING
FUNCTION

5

FULL GRILL
FUNCTION

6

DEFROST FUNCTION



BUILT-IN SOLUTIONS FOR SPACE SAVING

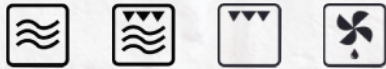

EFBM 2591 M

BUILT-IN MICROWAVE OVEN WITH GRILL

- 8 auto cooking menus
- Ø 315MM Turntable
- LED display
- Touch control door opening
- Microwave power: 900W
- Grill power: 1000W
- Total power load: 1450W
- Product Size: W594 x D403 x H382mm
- Built In Dimensions: W560 x D550 x H380mm

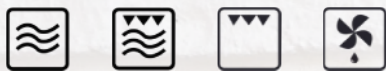

BM 259 M

BUILT-IN MICROWAVE OVEN WITH GRILL

- 10 auto cooking menus
- Ø 315MM Turntable
- LED display
- Push button door
- Microwave power: 900W
- Grill power: 1000W
- Total power load: 1450W
- Product Size: W594 x D410 x H388mm
- Built In Dimensions: W560 x D550 x H380mm



COMMON FEATURES

- 95 MINUTES TIMER
- COMBI MICROWAVE GRILLING FUNCTION

- CAVITY VOLUME: 25 LITRES
- FULL GRILL FUNCTION

- 5 MICROWAVE POWER LEVELS
- DEFROST FUNCTION



STANDING COOKER

A stunning centerpiece at home while complementing your kitchen interior design. Beautifully designed to please the eyes while offering remarkable capacity, flexibility and usability.

STANDING COOKER



EXPERIENCE POWER AND PRECISION

EF Standing Cooker flushes beautifully and installed perfectly aligned to the surrounding cabinets.

Incorporating distinctive design with technology to perform. Featuring classic stainless steel body, elegant knobs, and ergonomically designed handles with refined finishes. A timeless fit at home.



GC AE 9650 A SS FREE-STANDING COOKER

90cm range cooker with 5 burners gas hob:

- 1 triple ring burner - 3.5kW
- 1 fish burner - 2.5kW
- 2 semi-rapid burners - 1.75kW
- 1 auxiliary burner - 1.0kW

Electric Oven Capacity: 105L

8 functions

Electronic control

Digital clock with automatic cut-off timer

Cavity cooling system, double oven lights and double circulation fans

Easy clean removable inner glass door and double glazed glass door

Slide out storage compartment

Includes 2 grilling racks and 1 baking tray

Product Size: W900 x D600 x H910mm

Colour: Stainless steel





X



IN COLLABORATION WITH CREATIVE CULINAIRE



Laksa Baked Pasta



ENERGY SAVING
BAKING



1 HOUR



SERVES 4

Ingredients:

- 750g Cooked Linguine (Al-Dente)
- 200g Laksa Paste
- 4 Cloves of Garlic (Sliced)
- 20g Laksa Leaves (Finely Chopped)
- 100g Red Onions (Sliced)
- 350g Coconut Cream
- 200g Water
- ½ tsp Sugar
- 400g Prawns
- 400g Squid
- 500g Mozzarella Cheese

Method:

1. In a pot, fry Garlic and Red Onions till fragrant before adding in Laksa Paste and Laksa Leaves. Continue to fry for approx 7 minutes till fragrant.
2. Add in Coconut Cream, Water and Sugar. Bring Laksa Sauce to a boil and reduce to thicken.
3. Add in Cooked Linguine and mix well.
4. Place Laksa Pasta into an oven-safe dish.
5. Place Seafood over Pasta, followed by Cheese.
6. Bake Laksa Pasta in the oven using Energy Saving Baking Mode at 175°C for approx 10 minutes or till Seafood is cooked and Cheese has melted.

TIPS & TRICK

1. Add a few extra spoons of laksa sauce into the pasta before baking to prevent it from getting too dry.
2. You can also use the Top Heating function to cook this but we use the Eco function on EF oven for a faster and more energy efficient way to cook, especially for larger quantities.

BUILT IN DIMENSIONS

ELECTRIC HOBS

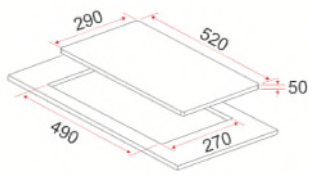

HB AV 231 A

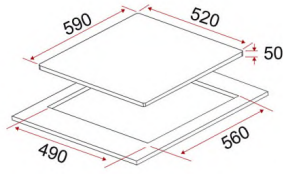

HB AV 461 A

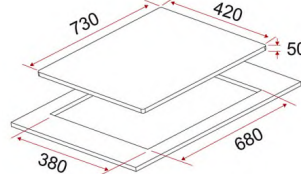

HB AV 271 A

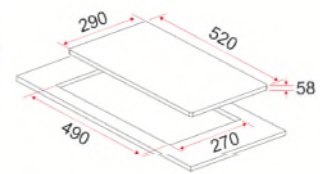

HB BI 292 A

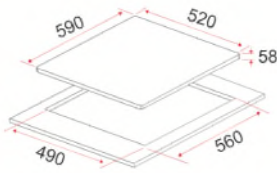

HB BI 583 A /
HB BI 584 FA

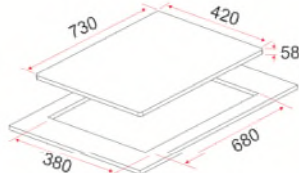

HB IV 2734 A /
HB BI 2730 / 2721 A

GLASS GAS HOBS

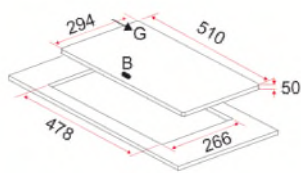

HB AG 3010 / 3020 TN VGB

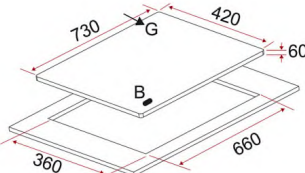

EFH 7620 / 7630 TN VGB

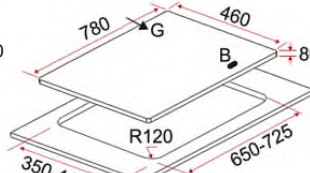

EFH 7626 / 7635 WT VGB

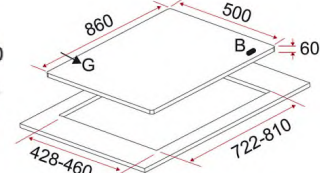

EFH 9720 / 9730 TN VGB

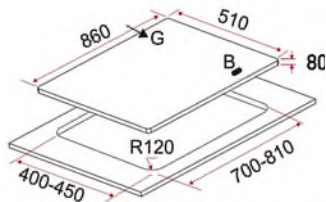

EFH 9733 WT VGB

STAINLESS STEEL GAS HOBS

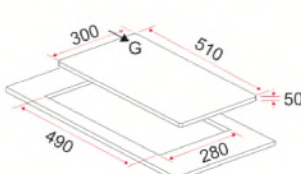

HB AG 130 / 230 VS A

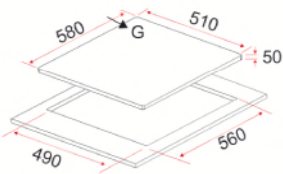

HB AG 360 VS A

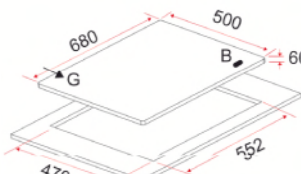

EFH 3760 / 3761 TN VSB

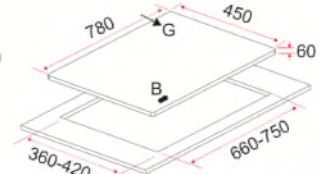

EFH 2760 / 3762 / 3763 TN VSB

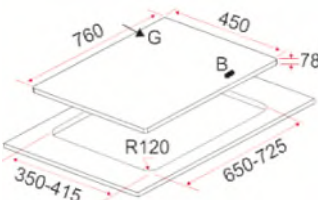

EFH 2763 / 3767 WT VSB

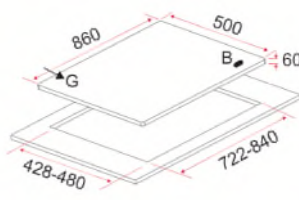

EFH 3970 / 3971 TN VSB

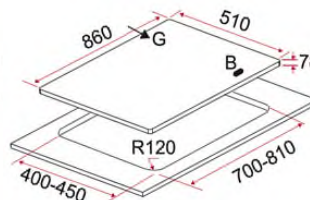

EFH 3976 WT VSB

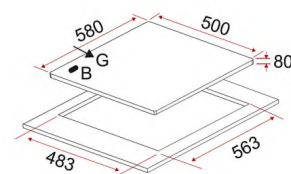

HB FG 3060 TN VSB

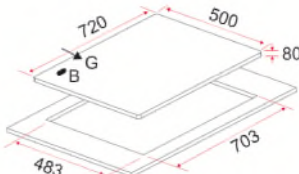

HB FG 3070 TN VSB

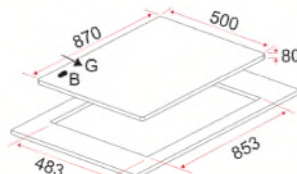

HB FG 4090 TN VSB

LEGEND:

G = GAS INLET

B = BATTERY BOX

DIMENSIONS ARE IN "MM"

BUILT IN DIMENSIONS

CHIMNEY HOODS

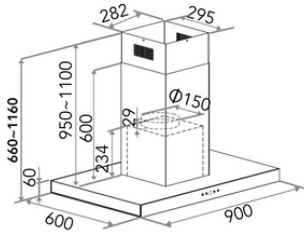

CK LUNA IS

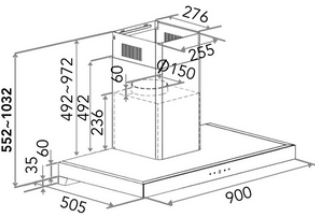

CK VISTA

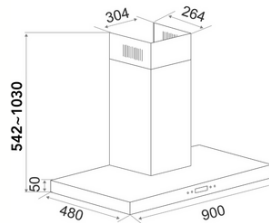

CK FINO SS

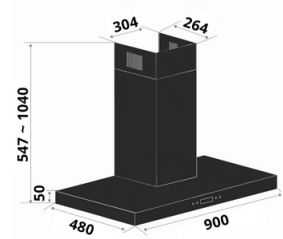

CK FINO PLUS BK

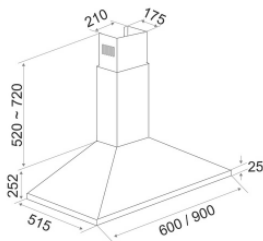

CK PREMIO 60/90

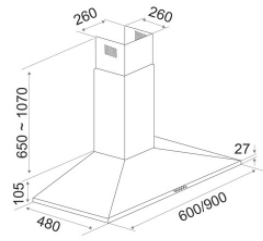

CK MIA 60/90

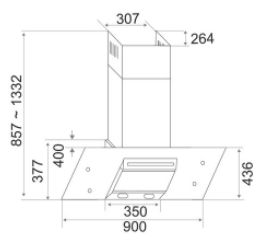

CH AG30 A

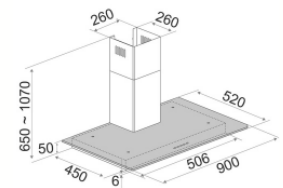

CK STILE

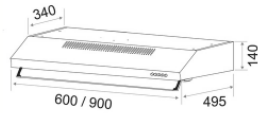

EFCH 6101 HM SSL
EFCH 9101 HM SSL

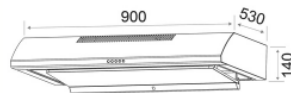

EFCH 9111 HM SS

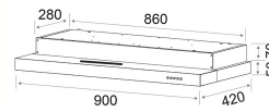

EFCH 9211 HM SS
EFCH 9212 HM BK

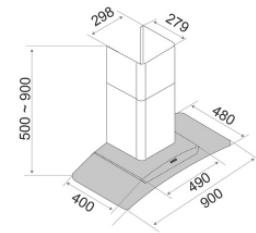

CK VETRO PLUS

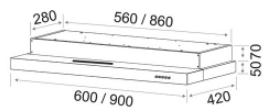

EFCH 6201 HM SSL
EFCH 6202 HM SSL

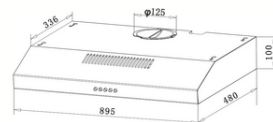

EFCH 9103T SS
EFCH 9108T BK

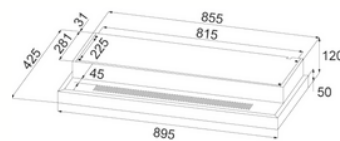

EFCH 9201T SS EFCH 9202T SS
EFCH 9231T SS EFCH 9236T SS
EFCH 9204T SS EFCH 9234T SS

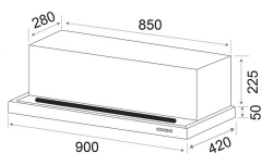

POWERSLIM 90 SSL
POWERSLIM 90 X/VL

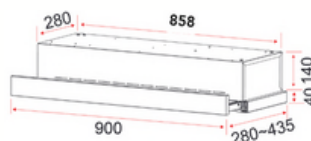

EFCH 9401 HM SS

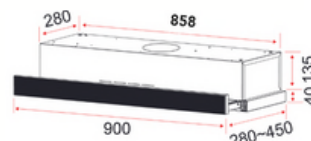

EFCH 9402 AL

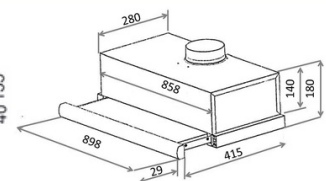

TF 5293/90

BUILT IN DIMENSIONS

BUILT-IN OVENS

BO GE 1771MW M
BO GE 1770SA M
BO AE 86 A
BO AE 63 A

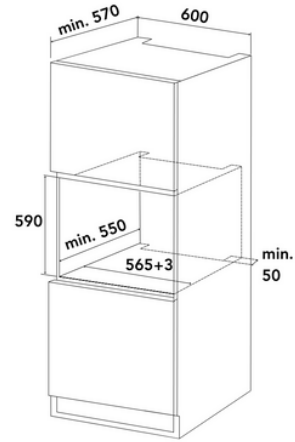
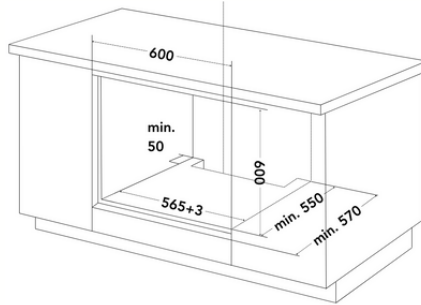

BO AE 62 A

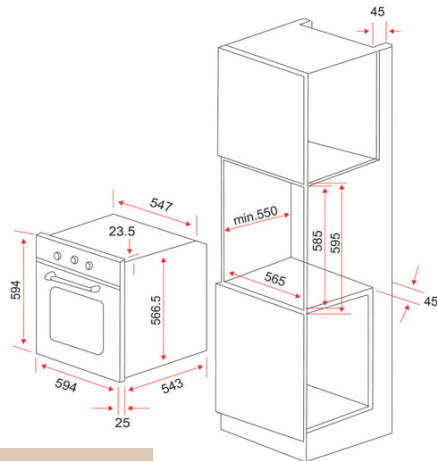
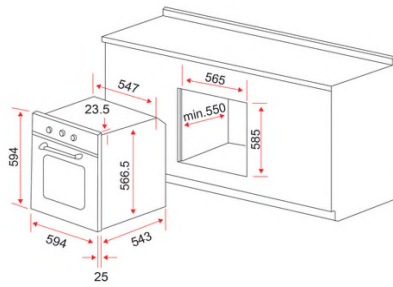

BUILT-IN MICROWAVE OVENS

BM 259 M

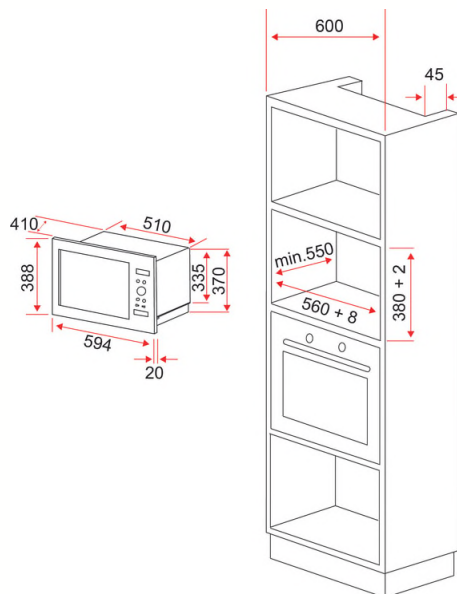

EFBM 2591 M

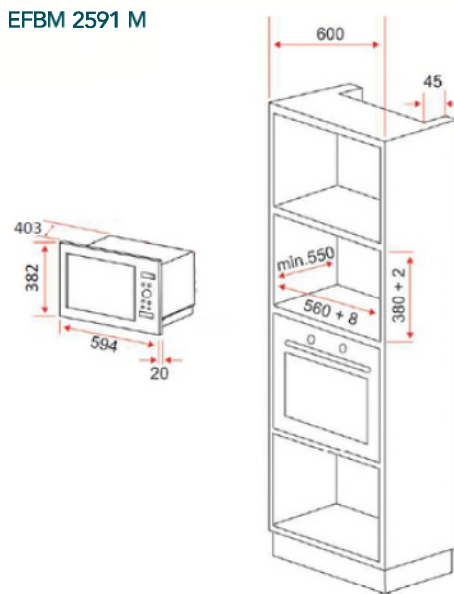

BUILT IN DIMENSIONS





Embracing Finest Moments



EF Home Appliances

✉ ef@casa.com.sg

🌐 www.ef.com.sg

@efappliances / EF Home Appliances



Marketed by Casa (S) Pte Ltd

📍 15 Kian Teck Crescent,
Singapore 628884

☎ +65 6268 0066 (General)

📞 +65 9747 8743 (Service)

🌐 www.casa.sg

📱 @casa.singapore